



PRODUCT OVERVIEW

# MOW-0001

Concealed Single-Lever Mixer with Cover Plate

<p><b>WIDTH</b></p> <p><b>Ø 78 mm</b></p>	<p><b>DEPTH</b></p> <p><b>75–95 mm recess depth</b></p>
<p><b>HEIGHT</b></p> <p><b>Ø 78 mm</b></p>	<p><b>INSTALLATION</b></p> <p><b>Concealed wall-mounted</b></p>
<p><b>MATERIAL</b></p> <p><b>Brass body</b></p>	<p><b>SHAPE</b></p> <p><b>Round cover plate</b></p>









PRODUCT SPECS

01

- Concealed single-lever mixer with cover plate
- Round cover plate Ø 78 mm
- Clean wall-mounted concealed installation
- Minimum recess depth: 75 mm
- Maximum recess depth: 95 mm
- Single-lever control for comfortable daily use
- Designed for premium modern bathroom interiors

FINISH VARIANTS

02

	Glossy White	MOW-0001-GW
	Snow White – Matte	MOW-0001-SW
	Matte Black	MOW-0001-MB
	Glossy Black – Mirror	MOW-0001-GB
	Bright Silver – Brushed	MOW-0001-BS
	Gunmetal – Brushed	MOW-0001-GMC
	Pickaxe Gold – Brushed	MOW-0001-PG
	Rose Gold – Brushed	MOW-0001-RG

PRODUCT DESCRIPTION

Modern concealed single-lever mixer with a round cover plate, designed for clean wall-mounted installation. Suitable for premium bathroom applications where a minimal visible control element and concealed internal body are required.

DIMENSIONAL DRAWING

MM

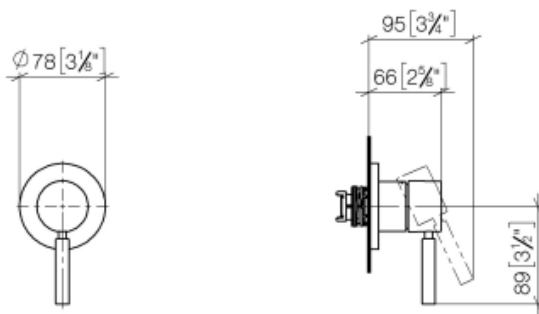

All dimensions are shown in millimetres unless otherwise stated. Site conditions, cut-out, trap system and mixer clearance should be verified before installation.

TECHNICAL DATA

03

Product type	<b>Concealed single-lever mixer</b>
Installation	<b>Concealed wall-mounted</b>
Material	<b>Brass body</b>
Shape	<b>Round cover plate</b>
Width	<b>Ø 78 mm</b>
Depth	<b>75–95 mm recess depth</b>
Height	<b>Ø 78 mm</b>
Tap hole	<b>Concealed wall-mounted installation</b>
Cover plate diameter	<b>Ø 78 mm</b>
Minimum recess depth	<b>75 mm</b>
Maximum recess depth	<b>95 mm</b>
Installation type	<b>Concealed wall-mounted</b>
Control type	<b>Single-lever</b>
Visible component	<b>Round cover plate with lever handle</b>

CODES & STANDARDS

04

